

Installation

Note The product model shown in this QIG is TD-W8961ND, as an example.

1

Connecting the device

Note Please use only wired network connections to configure the Modem Router.

1 If you currently use a modem, disconnect it now - the Modem Router will replace your current modem.

2 Connect your computer to the Port labeled "1~4" on the Modem Router with an Ethernet cable.

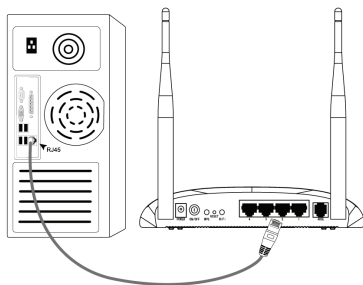

3 Connect the splitter to the wall jack using a telephone line, then use the other telephone line to directly connect it to the ADSL port on the Modem Router and the MODEM port of the splitter, also have the PHONE port of the splitter connected to a telephone.

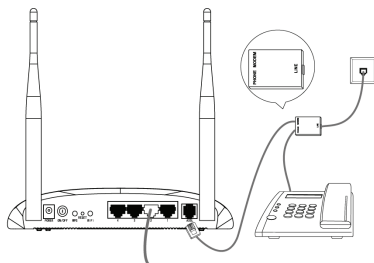

Note If no telephone is needed, please connect the ADSL port of the Modem Router to the wall jack using the telephone line directly.

- 4** Plug the provided Power Adapter into the Power jack on the back of the Modem Router and the other end to a standard electrical wall socket.

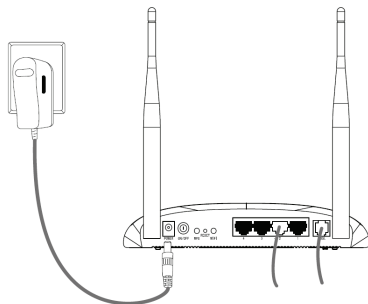

- 5** Power on all your network devices and then check to see if the LEDs of the Modem Router display normally as the diagram below describes.

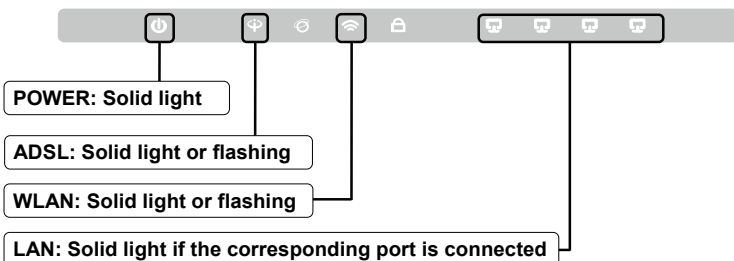

Note If the LEDs display abnormally, please check to see if all the cable connectors (power adapter, phone line and Ethernet cable) are well connected to your device. With the phone line well connected, if the ADSL LED turns off after flashing, please contact your ISP to ensure that your Internet connection is active.

2

Configuring the device

Note To configure the device, you can either run the setup CD (method one), or run the Web-based Quick Setup Wizard (method two). TP-LINK strongly recommends that you run the setup CD.

Use the CD

- 1 Insert the provided Resource CD into your CD-ROM drive.

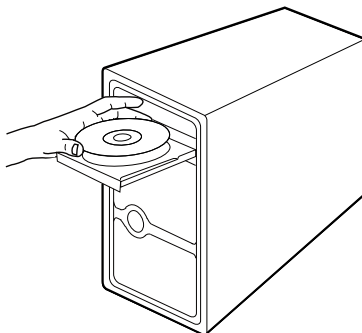

- 2 The Setup Wizard will automatically pop up on your computer's screen.

Please select your product model and click **Start Setup**

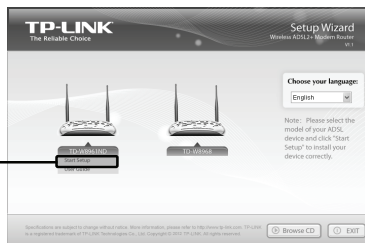

Then a flash video will pop up and show you how to connect your devices. After that, the **Easy Setup Assistant** will start.

Click **NEXT**, and then follow the step-by-step instructions until you complete the configuration

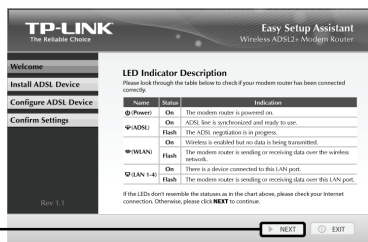

The configuration has now been completed. Please skip to **Step 3 “Testing the Internet Connection”**.

3

Testing the Internet Connection

The basic settings for your Modem Router are completed. Please open the web browser and try to log on to some popular website to test your Internet connection, for example:

<http://www.tp-link.com>

<http://www.google.com>

If the above websites can be accessed, it indicates that your Modem Router has been configured successfully and you can start to enjoy the Internet. If the websites cannot be accessed, please refer to **“T4. What can I do if I cannot access the Internet?”** in the **Troubleshooting** guide.

Note For the advanced configurations, please refer to the User Guide on the CD provided.

Note The above configurations only need to be set once. If you want other computers in your LAN to access the Internet, please connect the desired computer to the ADSL Modem Router directly. If the additional computer can not access the Internet, please set that computer referring to **“T3. What can I do if I cannot access the web-based configuration page?”** in the **Troubleshooting** guide.

Troubleshooting

T1. How do I restore my Modem Router's configuration to its factory default settings?

With the Modem Router powered on, press and hold the **RESET** button on the rear panel for 8 to 10 seconds before releasing it.

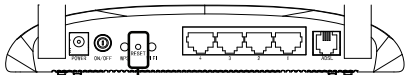

Press it for 8 to 10 seconds

Note Once the Modem Router is reset, the current configuration settings will be lost and you will need to re-configure the Modem Router.

T2. What can I do if I don't know or forget my password?

- 1) Restore the Modem Router's configuration to its factory default settings. If you don't know how to do that, please refer to section **T1**.
- 2) Use the default user name and password: **admin, admin**.
- 3) Try to configure your Modem Router once again by following the instructions in the previous steps of the QIG.

T3. What can I do if I cannot access the web-based configuration page?

- 1) Configure your computer's IP Address.

For Windows 7 OS

Go to **Start > Settings > Control Panel**, and then you will see the following page.

Click **View network status and tasks**

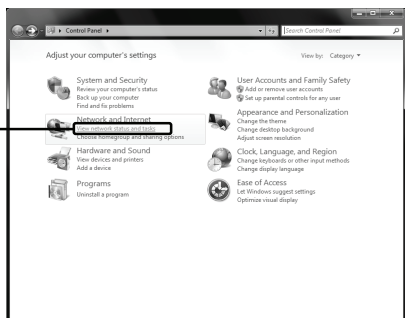

Click **Change adapter settings**

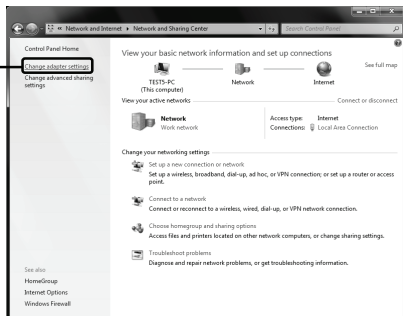

Right-click **Local Area Connection**

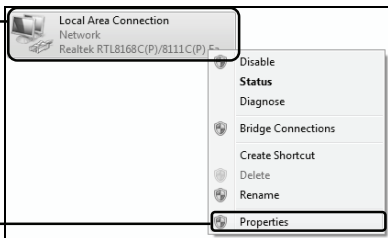

Click **Properties**

Double-click **Internet Protocol Version 4 (TCP/IPv4)**

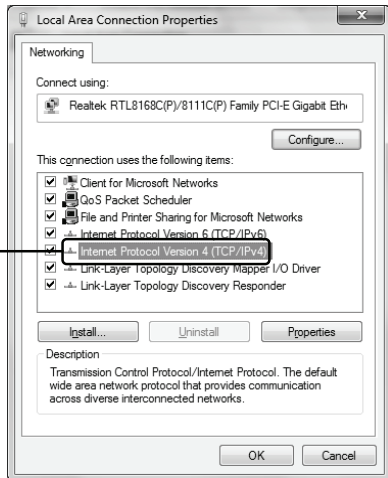

Select **Obtain an IP address automatically**

Select **Obtain DNS server address automatically**

Click **OK**

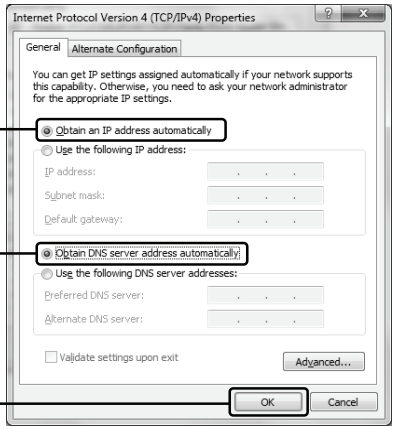

For Windows Vista OS

Go to **Start > Settings > Control Panel**, and then you will see the following page.

Click **View network status and tasks**



Click **View status**

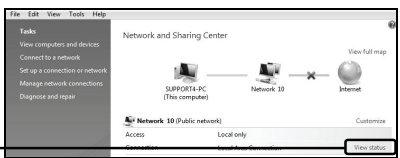

Click **Properties**

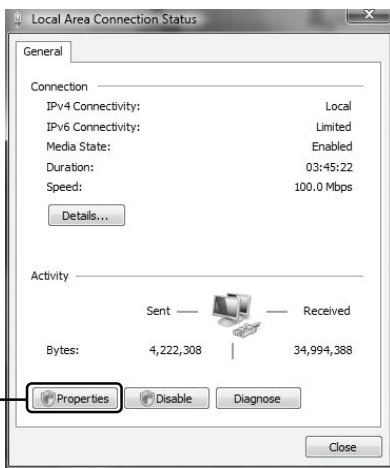

Double-click **Internet Protocol Version 4 (TCP/IPv4)**

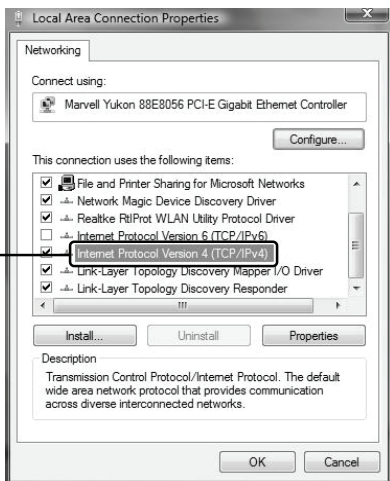

Select **Obtain an IP address automatically**

Select **Obtain DNS server address automatically**

Click **OK**

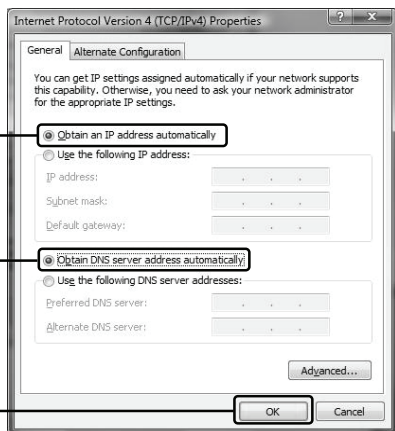

For Windows XP OS

Go to **Start > Control Panel**, you will then see the following page.

Click **Network and Internet Connections**

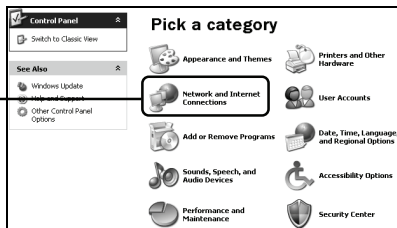

Click **Network Connections**

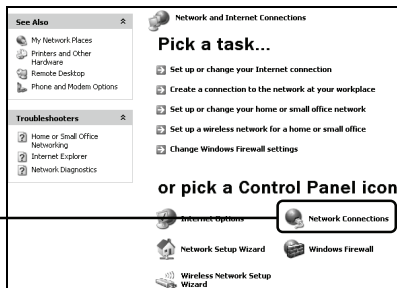

Right-click **Local Area Connection**

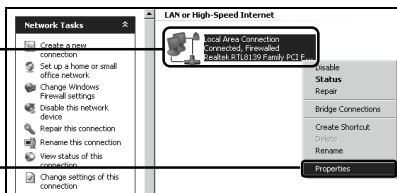

Click **Properties**

Double-click **Internet Protocol (TCP/IP)**

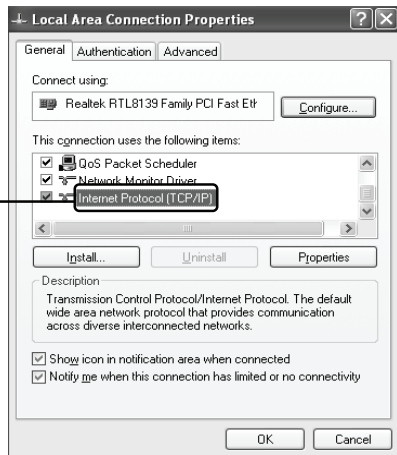

Select **Obtain an IP address automatically**

Select **Obtain DNS server address automatically**

Click **OK**

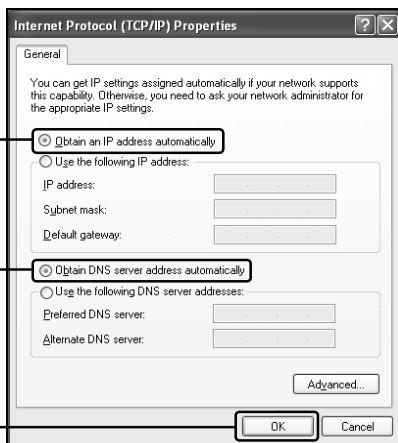

Click **OK**

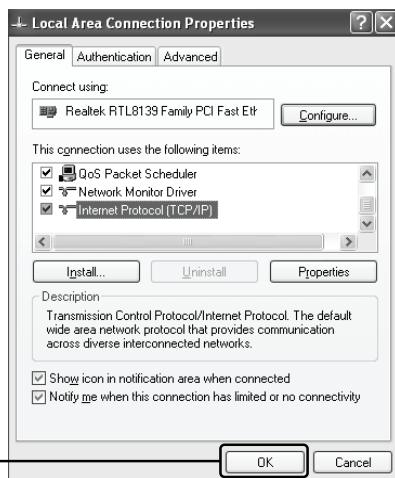

2) Configure your IE browser.

Open your IE browser, click **Tools** tab and you will see the following screen.

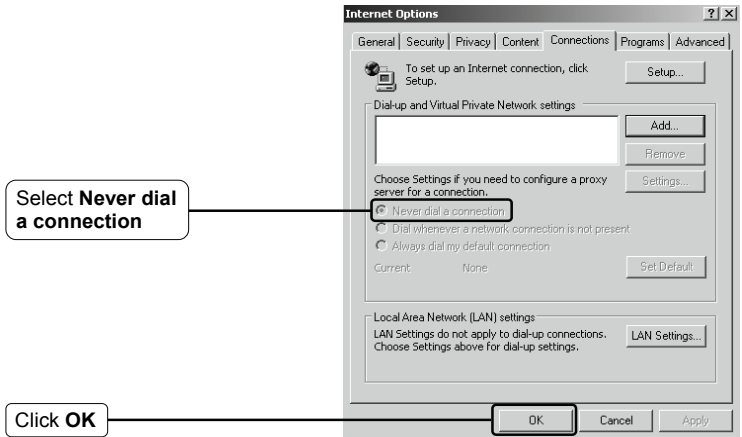
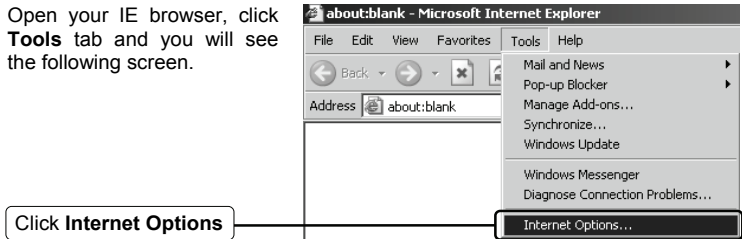

Now, try to log on to the Web-based configuration page again after the above settings have been configured. If you still cannot access the configuration page, please restore your Modem Router's factory default settings and reconfigure your Modem Router following the instructions of this QIG. Please feel free to contact our Technical Support if the problem persists.

T4. What can I do if I cannot access the Internet?

- 1) Check to see if all the connectors are connected well, including the telephone line, Ethernet cables and power adapter.
- 2) Check to see if you can log on to the web management page of the Modem Router. If you can, try the following steps. If you cannot, please set your computer referring to **T3** then try to see if you can access the Internet. If the problem persists, please go to the next step.
- 3) Consult your ISP and make sure all the VPI/VCI, Connection Type, account username and password are correct. If there are any mistakes, please correct the settings and try again.
- 4) If you still cannot access the Internet, please restore your Modem Router to its factory default settings and reconfigure your Modem Router by following the instructions of this QIG.
- 5) Please feel free to contact our Technical Support if the problem still exists.

Note For more details about Troubleshooting and Technical Support contact information, please log on to our Technical Support Website: <http://www.tp-link.com/en/support>

Appendix

Configuration for Mac OS/Linux/Windows/Android/iOS users who cannot run the mini CD

1 Login

Open your web browser and type **192.168.1.1** in the address bar and press **Enter**

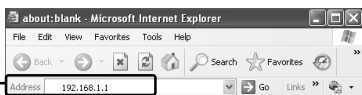

A dialog box will prompt you for the **User name** and **Password**. Enter the default values and click **OK**.



User name: admin
Password: admin

Click **OK**

Note If the dialog box does not pop up, please refer to **T3** in the **Troubleshooting** guide and **T2** will give you some help if you forget the password.

The web management page will display after a successful login.

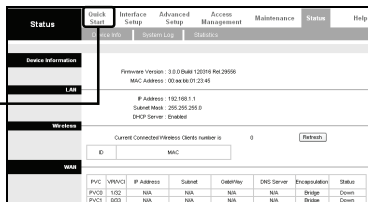

Click **Quick Start**

2 Internet Parameters Configuration

This page will then display.

Click **RUN WIZARD**

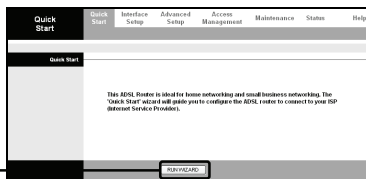

Click **NEXT**

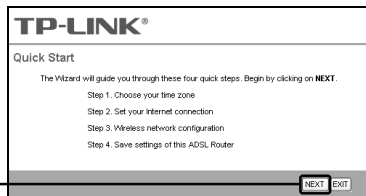

Select the appropriate **Time Zone** for your location from the drop-down list

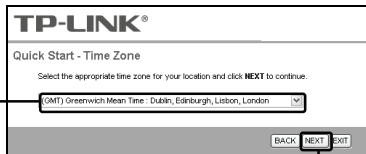

Click **NEXT**

Choose the **Connection Type** given by your ISP.
If **PPPoE/PPPoA** is selected, please proceed to **A**;
If **Dynamic IP** is selected, please skip to **B**;
If **Static IP** is selected, please skip to **C**;
If **Bridge Mode** is selected, please skip to **D**.

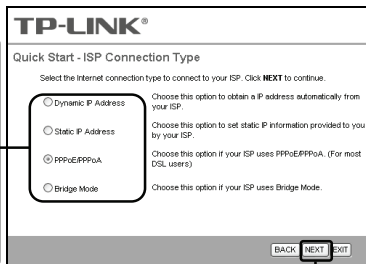

Click **NEXT**

Note

Bridge mode is not recommended because multiple computers are not permitted to share Internet access in this mode.

A. Configuration for PPPoE/PPPoA

This page will then display.

Enter the **PPPoE/PPPoA** information provided by your ISP

Click **NEXT**

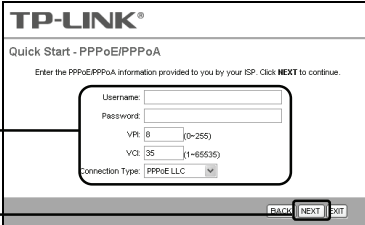

Note If you did not get the **VPI**, **VCI** and **Connection Type** information, please contact your ISP for this information.

B. Configuration for Dynamic IP

This page will then display.

Select the **dynamic connection** provided by your ISP

Click **NEXT**

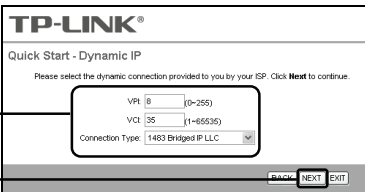

C. Configuration for Static IP

This page will then display.

Enter the **Static IP** information provided by your ISP manually

Click **NEXT**

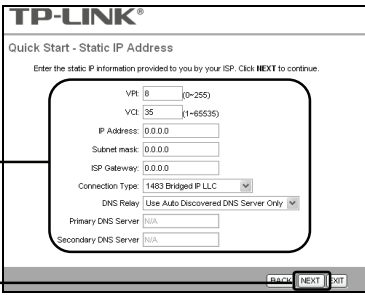

D. Configuration for Bridge Mode

This page will then display.

Enter the **Bridge** information provided by your ISP

Click **NEXT**

TP-LINK®
Quick Start - Bridge Mode
Enter the bridge information provided to you by your ISP. Click **NEXT** to continue.

VPI: 8 (0-255)
VCI: 35 (1-65535)
Connection Type: 1483 Bridged IP LLC

BACK NEXT GOT

After completing the above configuration, please proceed to **3 Wireless Settings Configuration**

3 Wireless Settings Configuration

This page will then display.

Keep the default setting: **Activated**. If you want to disable Access Point, please select **Deactivated**

Create a unique and easy to remember name for your wireless network. You can also keep default settings without the device being affected

Select an **Authentication Type**

Select an **Encryption** type

Enter a Security Key using 8-64 characters

Click **NEXT**

TP-LINK®
Quick Start - Wlan
You may enable/disable Wlan, change the Wlan SSID and Authentication type in this page. Click **NEXT** to continue.

Access Point: Activated Deactivated

SSID: TP-LINK_987654

Broadcast SSID: Yes No

Authentication Type: WPA-PSK

Encryption: TKIP/AES

Pre-Shared Key: ASCII characters (64 hexadecimal characters)

BACK NEXT GOT

Note The wireless security is **Disabled** by default. You are suggested to select an **Authentication Type** for security settings. WPA2-PSK is recommended.

After completing the above configuration, please proceed to **4 Quick Start Complete**.

4 Quick Start Complete

To continue, the following page will be displayed.

Click **NEXT**

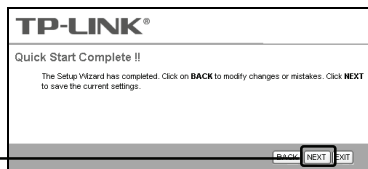

Click **CLOSE**



Now, your Modem Router has been configured and is rebooting. Please do not turn off the Modem Router while it's rebooting.

Technical Support

- For more troubleshooting help, go to:
www.tp-link.com/support/faq.asp
- To download the latest Firmware, Driver, Utility and User Guide, go to:
www.tp-link.com/support/download.asp
- For all other technical support, please contact us by using the following details:

Global

Tel: +86 755 26504400
E-mail: support@tp-link.com
Service time: 24hrs, 7 days a week

Singapore

Tel: +65 62840493
E-mail: support.sg@tp-link.com
Service time: 24hrs, 7 days a week

UK

Tel: +44 (0) 845 147 0017
E-mail: support.uk@tp-link.com
Service time: 24hrs, 7 days a week

USA/Canada

Toll Free: +1 866 225 8139
E-mail: support.usa@tp-link.com
Service time: 24hrs, 7 days a week

Malaysia

Tel: 1300 88 875465 (1300 88TPLINK)
Email: support.my@tp-link.com
Service time: 24hrs, 7 days a week

Turkey

Tel: 444 19 25 (Turkish Service)
E-mail: support.tr@tp-link.com
Service time: 9:00 AM to 6:00 PM
7 days a week

Poland

Tel: +48 (0) 801 080 618 / +48 22
7217563 (if calls from mobile phone)
E-mail: support.pl@tp-link.com
Service time: Monday to Friday 9:00 AM
to 5:00 PM. GMT+1 or GMT+2
(Daylight Saving Time)

Germany/Austria

Tel: +49 1805 875465 (German Service)
+49 1805 TPLINK
E-mail: support.de@tp-link.com
Fee: 0.14 EUR/min from the German
fixed phone network and up to 0.42
EUR/min from mobile phone
Service time: Monday to Friday 9:00 AM
to 6:00 PM. GMT+ 1 or GMT+ 2
(Daylight Saving Time in Germany)
*Except bank holidays in Hesse

Australia & New Zealand

Tel: AU 1300 87 5465
NZ 0800 87 5465
E-mail: support@tp-link.com.au
Service time: 24hrs, 7 days a week

Italy

Tel: +39 02 66987799
E-mail: support.it@tp-link.com
Service time: Monday to Friday
9:00 AM to 6:00 PM

Ukrainian

Tel: +380 (44) 590-51-14
E-mail: support.ua@tp-link.com
Service time: Monday to Friday
14:00 PM to 22:00 PM

Brazilian

Toll Free: 0800-770-4337 (Portuguese
Service)
E-mail: suporte.br@tp-link.com
Service time: Monday to Saturday
08:00 AM to 08:00 PM

Indonesia

Tel: +(62) 021 6259 135
E-mail : support.id@tp-link.com
Service time : Monday to Friday
9:00 -12:00; 13:00 -18:00
*Except public holidays

Switzerland

Tel: +41 (0) 848 800998 (German Service)
E-mail: support.ch@tp-link.com
Fee: 4-8 Rp/min, depending on rate of
different time
Service time: Monday to Friday 9:00 AM to
6:00 PM. GMT+ 1 or GMT+ 2
(Daylight Saving Time)

Russian Federation

Tel: 8 (499) 754-55-60
8 (800) 250-55-60 (toll-free call from any
RF region)
E-mail: support.ru@tp-link.com
Service time: From 10:00 to 18:00
(Moscow time)
*Except weekends and holidays in Russian
Federation

